

**GLOBAL ZZ 217**

**GLOBAL ZZ 217-3S**

**GLOBAL ZZ 217-P-3S**

service manual



Turn off the power switch when carrying out inspection, adjustment and maintenance

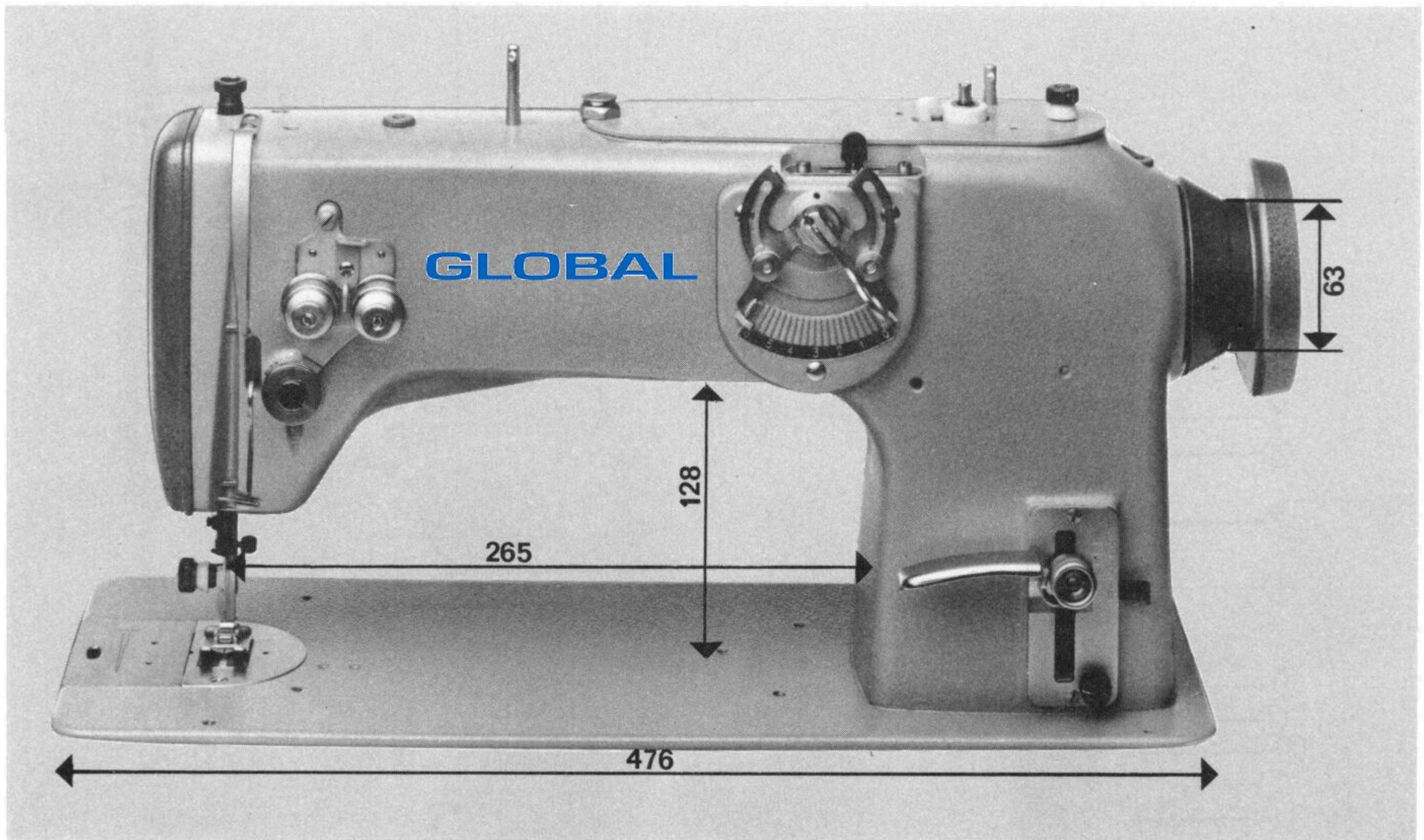

Base plate	: 476 × 178 mm
Working space to the right of the needle	: 265 × 128 mm

Needle throw and sewing speed

4.5 mm	2800 stitches per minute
6.0 mm	2800 stitches per minute
8.0 mm	2600 stitches per minute
12.0 mm	2200 stitches per minute.

Machines with cam device for utility and decorative stitches, stitches per minute for decorative-utility stitch

6.0 mm	2,300	2,800
8.0 mm	2,100	2,800
12.0 mm	1,800	2,600

Machines with other extra attachments such as:

Puller	as basic model
--------	----------------

Stitch displacement:	left-centre-right
Stitch length forward and reverse:	5.5 mm
Max. presser foot lift:	8.5 mm
Needle system:	12.0 mm needle throw = 134 R, No. 70–120
Shuttle system:	continuous double rotation, transverse position
Thread tension:	double thread tension
Raising presser foot:	knee lever with extra upper holding position.

**Important points to note:**

- Oil machine thoroughly before using for first time.
- When doing so, strictly observe instructions.
- Check that the mains voltage corresponds to the voltage given on the motor. If the voltages are not the same, do not on any account operate the machine.
- Check the guards for finger, take-up lever and belt are all present.
- When the machine is running the hand wheel should turn anti-clockwise. If it does not, reverse the terminals on the motor.
- Use only recommended needle system.
- Clean machine regularly.
- Do not start machine until the fabric is in position under the presser foot.
- When removing fabric always bring thread take-up lever at highest position.
- For the first 2 weeks, run machine at only  $\frac{3}{4}$  of its maximum speed.
- The presser foot can be raised either with the hand lever or with the knee lever.
- When making adjustments to the machine and when sewing is finished the motor should be switched off or disconnected at the mains. When using a clutch motor, wait until it has stopped.

# GLOBAL

## List of parts

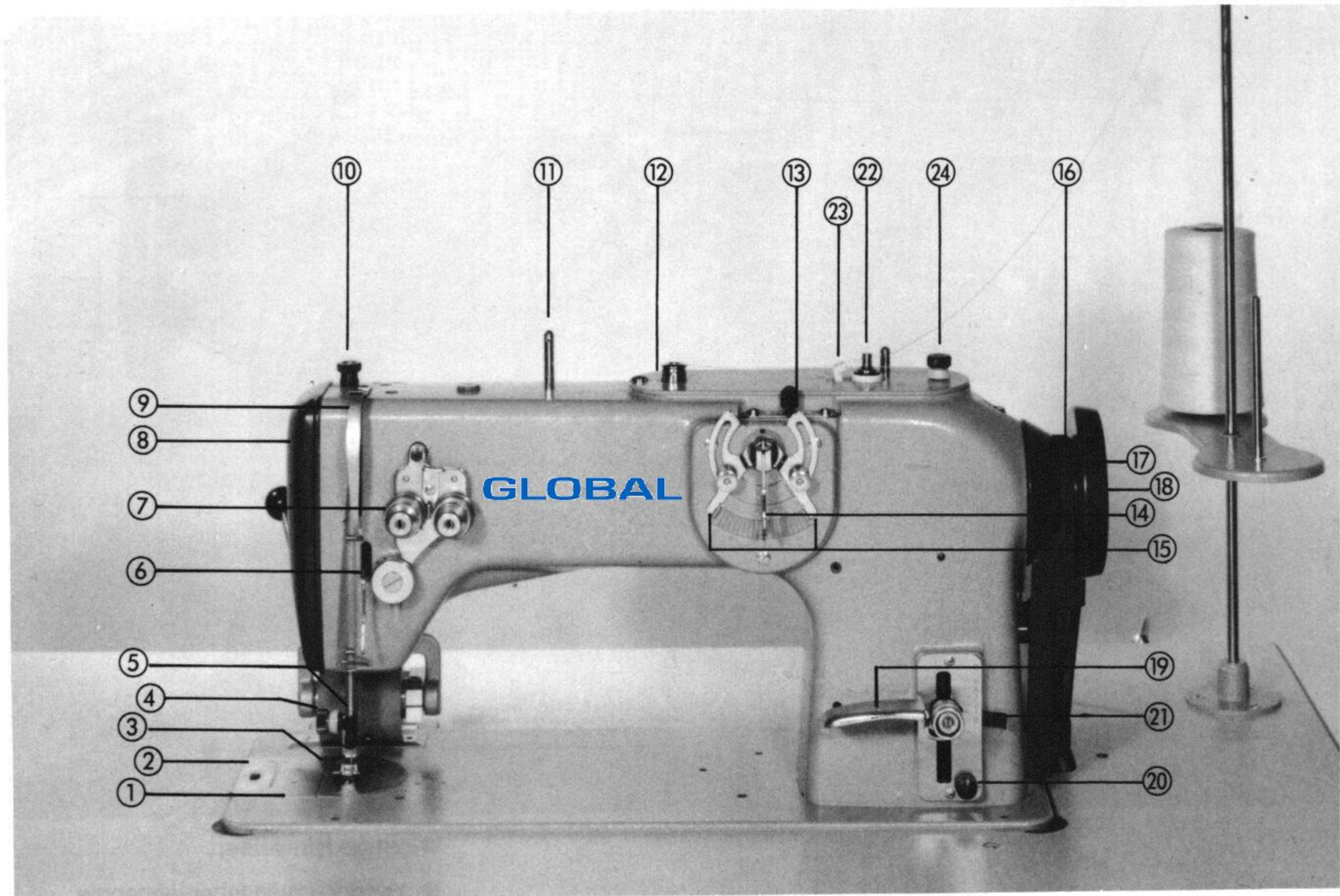

- 1 Base plate
- 2 Base plate slide
- 3 Needle plate
- 4 Presser foot screw and thread cutter
- 5 Needle holder
- 6 Thread regulator
- 7 Double thread tension
- 8 Front cover
- 9 Thread take-up lever
- 10 Regulating screw for presser foot pressure
- 11 Thread guide pin  
Embroidery machine: thread draw-off
- 12 Arm cover with bobbin winder
- 13 Lever for needle position
- 14 Lever for stitch width
- 15 Stops for limited stitch width
- 16 Belt guard
- 17 Hand wheel
- 18 Hub for synchroniser
- 19 Lever for stitch length
- 20 Knob for fine setting of stitch length,  
for sewing satin stitch
- 21 Buttonhole density stop
- 22 Bobbin winder
- 23 Bobbin winder engaging lever
- 24 Thread cutter

# GLOBAL

## Cleaning and oiling

### Cleaning

Remove needle plate ③ from time to time and remove any pieces of thread.

### Oiling

Oil all points marked red (with the exception of the shuttle system) with "Mobil Oil DTE Heavy Medium" or oil of comparable quality (Fig. 1-4).

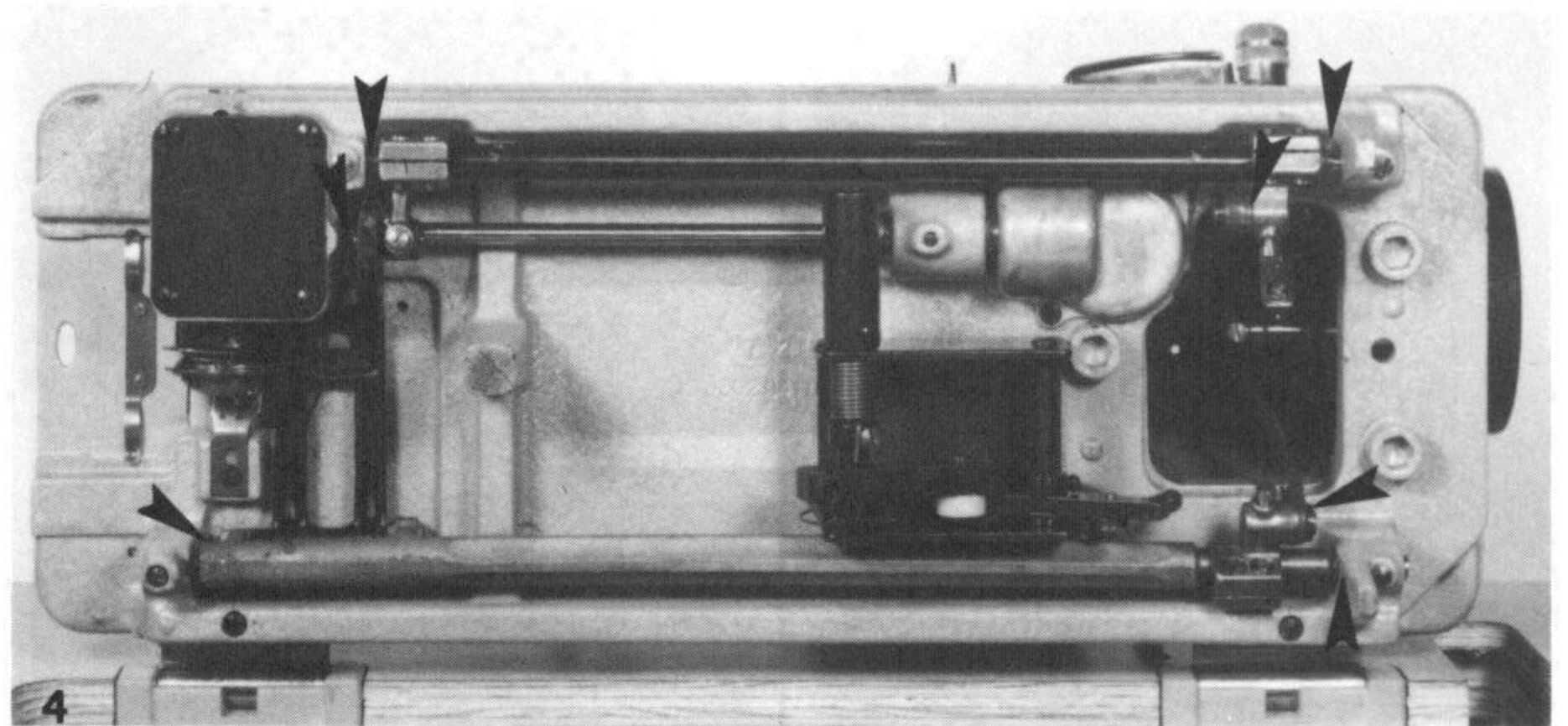
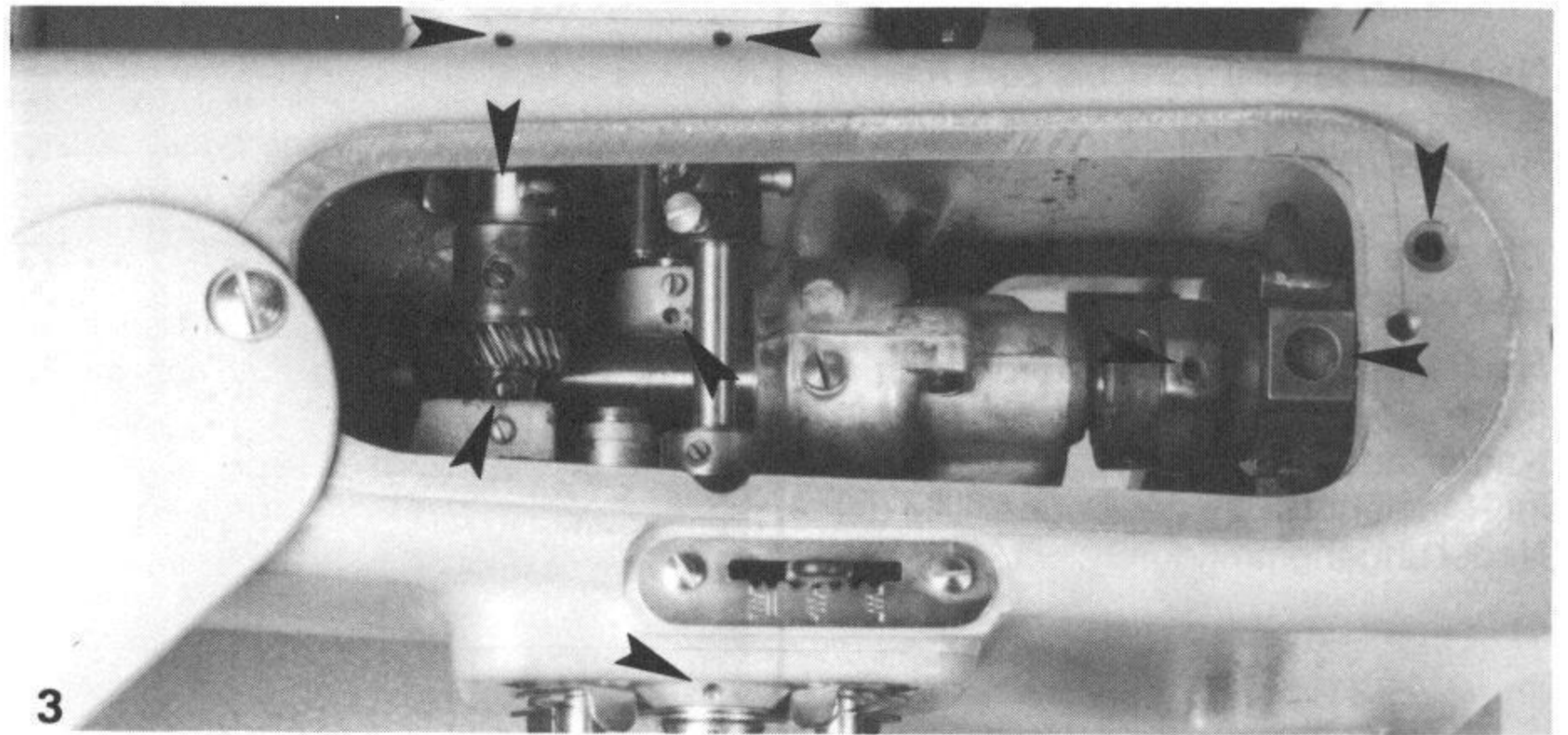
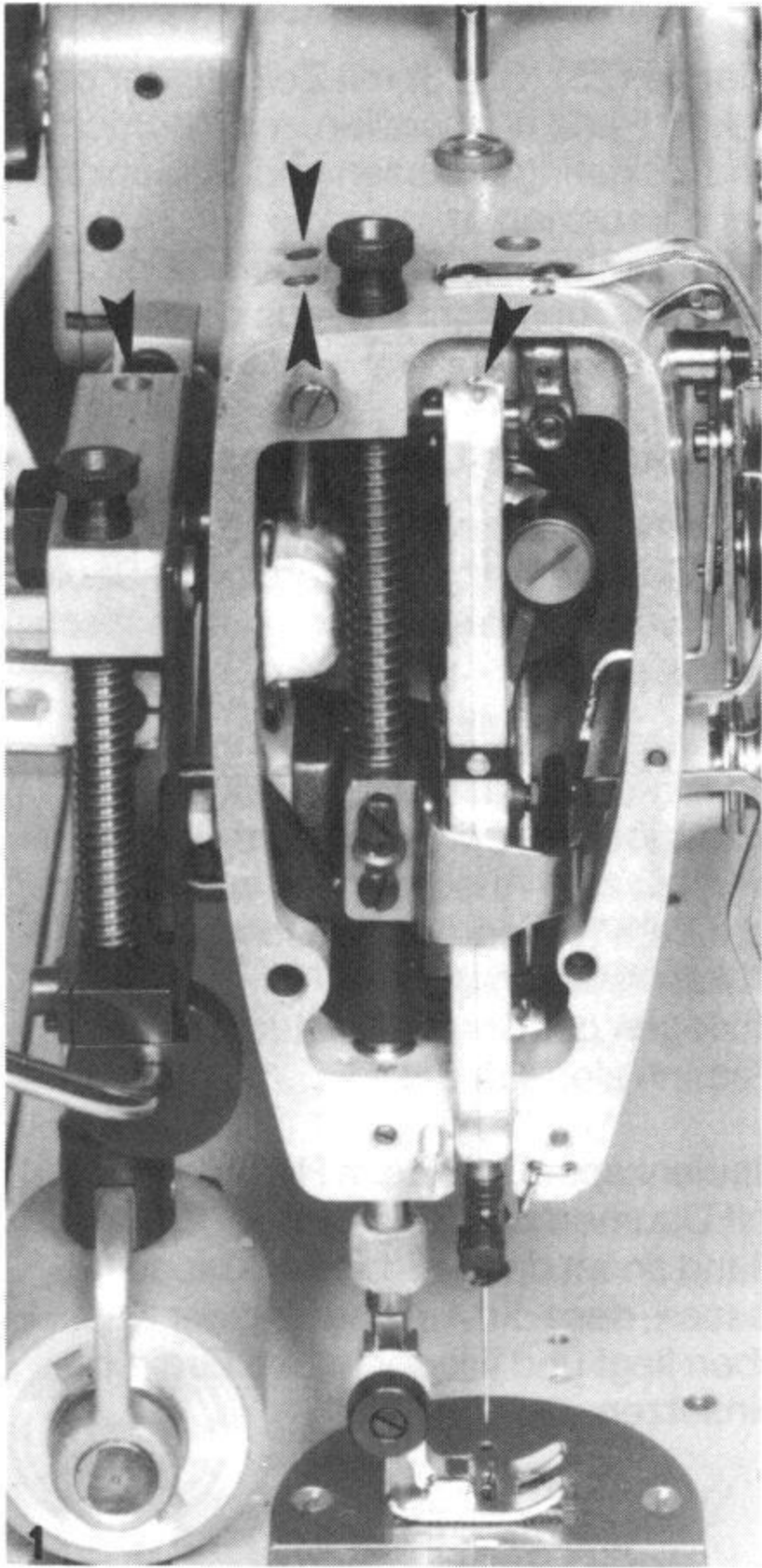

### Lubricating the hook

Remove slide ②, turn hand wheel till the oiling point on the hook is visible. This point must be oiled daily with the oil "Vélocité 10" given with the machine or a comparable, very light oil (Fig. 5).

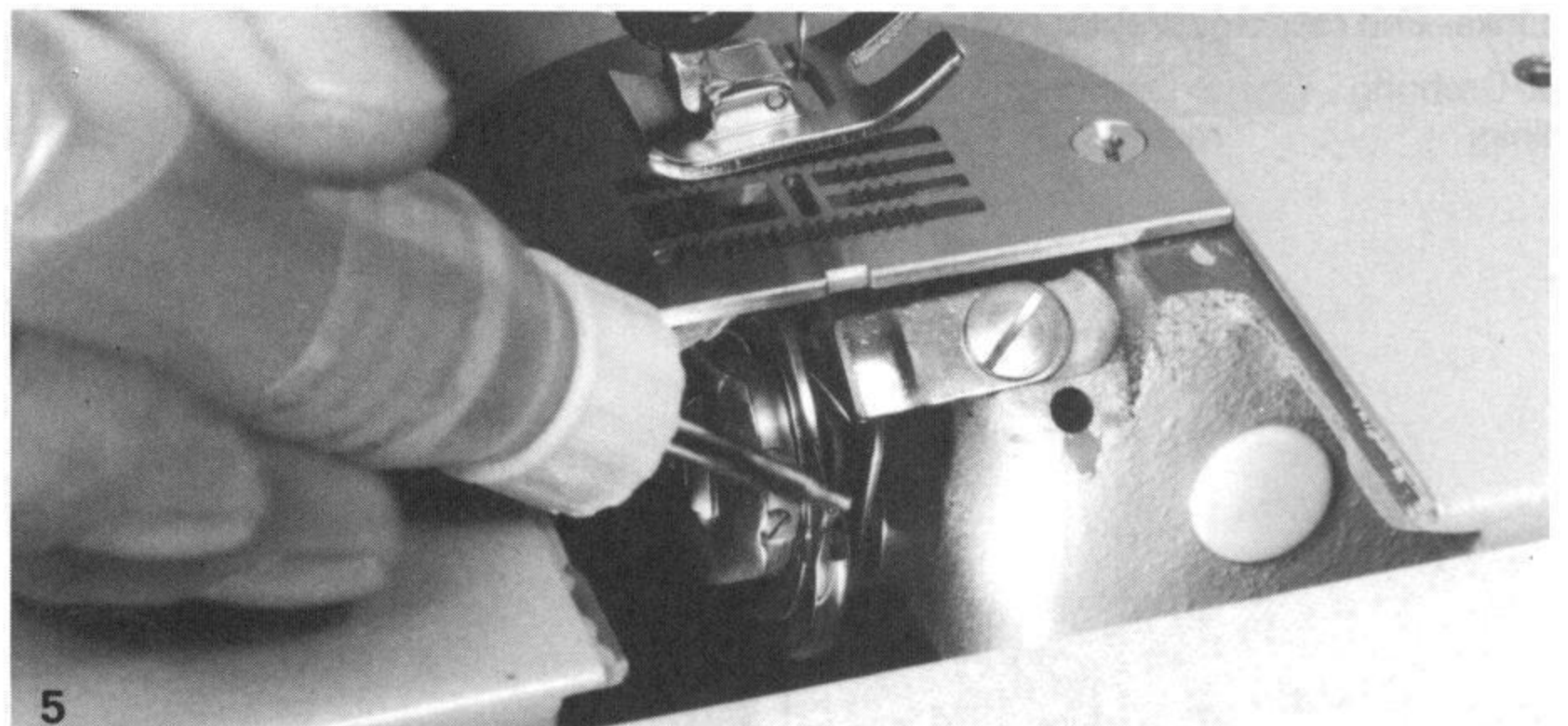

## Needle and thread

## bobbin case

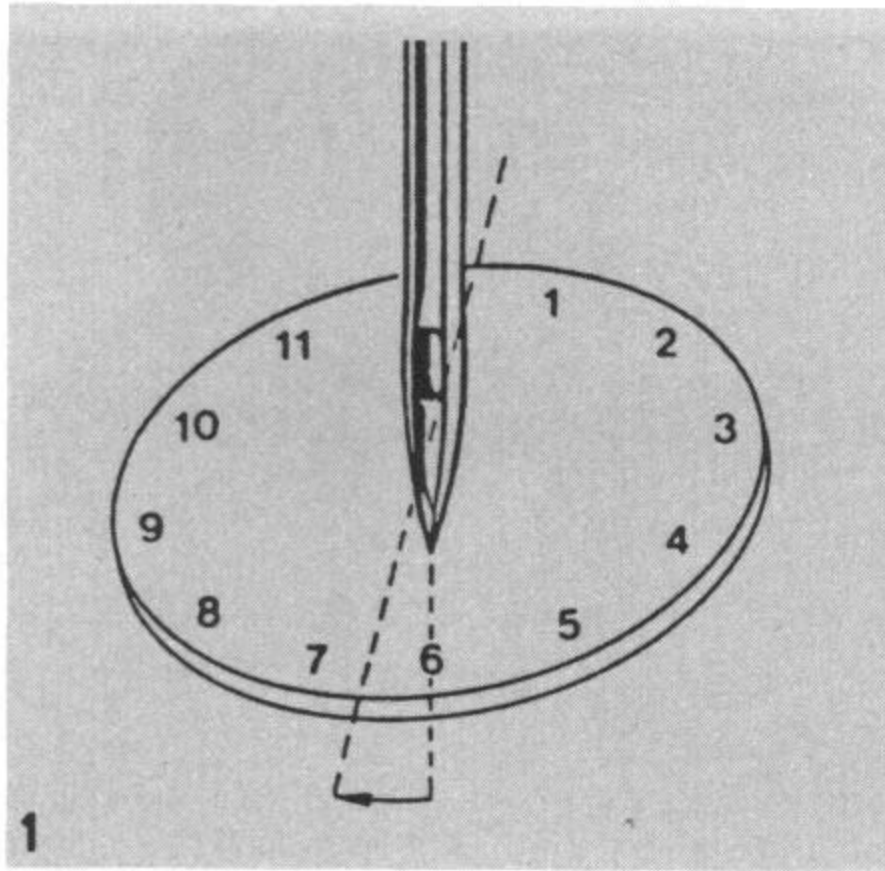

### Inserting the needle

Insert needle as far as it will go, with long groove at front. Position shown in Fig. 1.

### The correct choice of needle and thread

Use only left-twisted thread (z-twist) whenever possible (Fig. 2). The needle size is correct if the thread runs smoothly through the eye and the long groove of the needle.

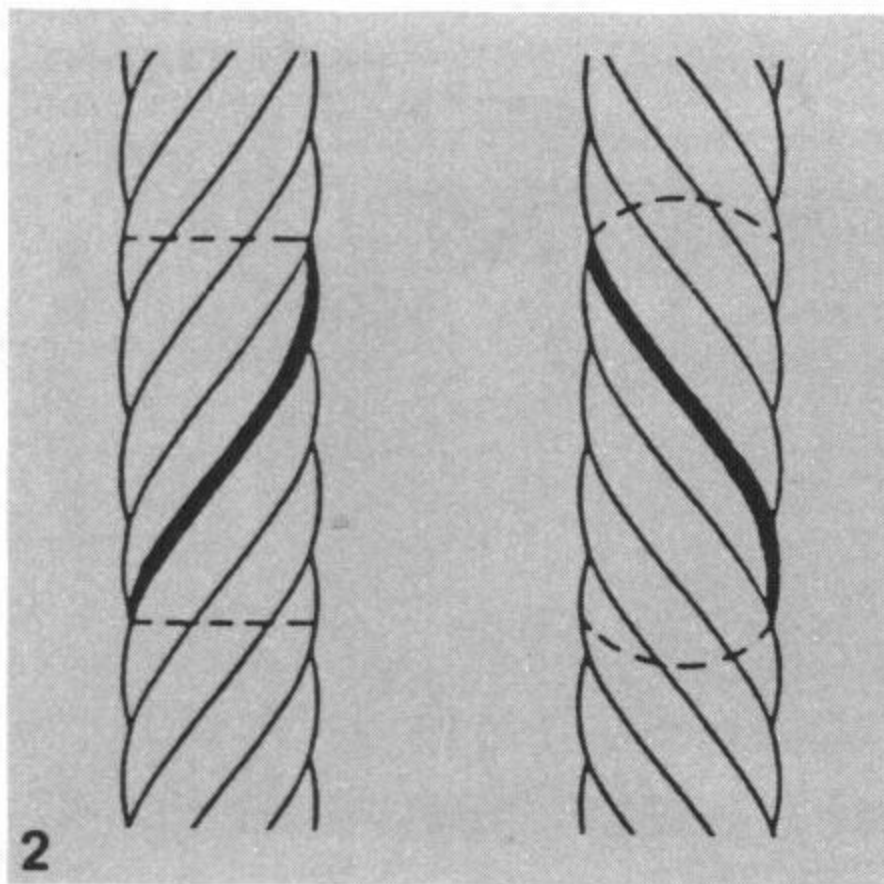

### Left and right-twisted thread

Z-twist  
left

S-twist  
right

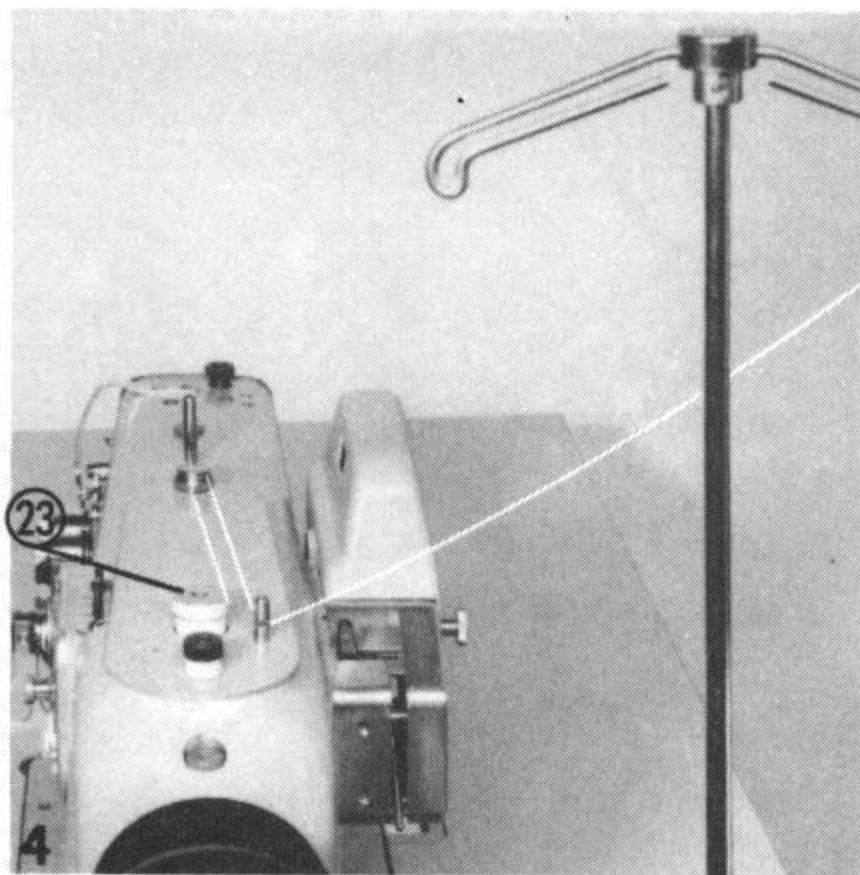
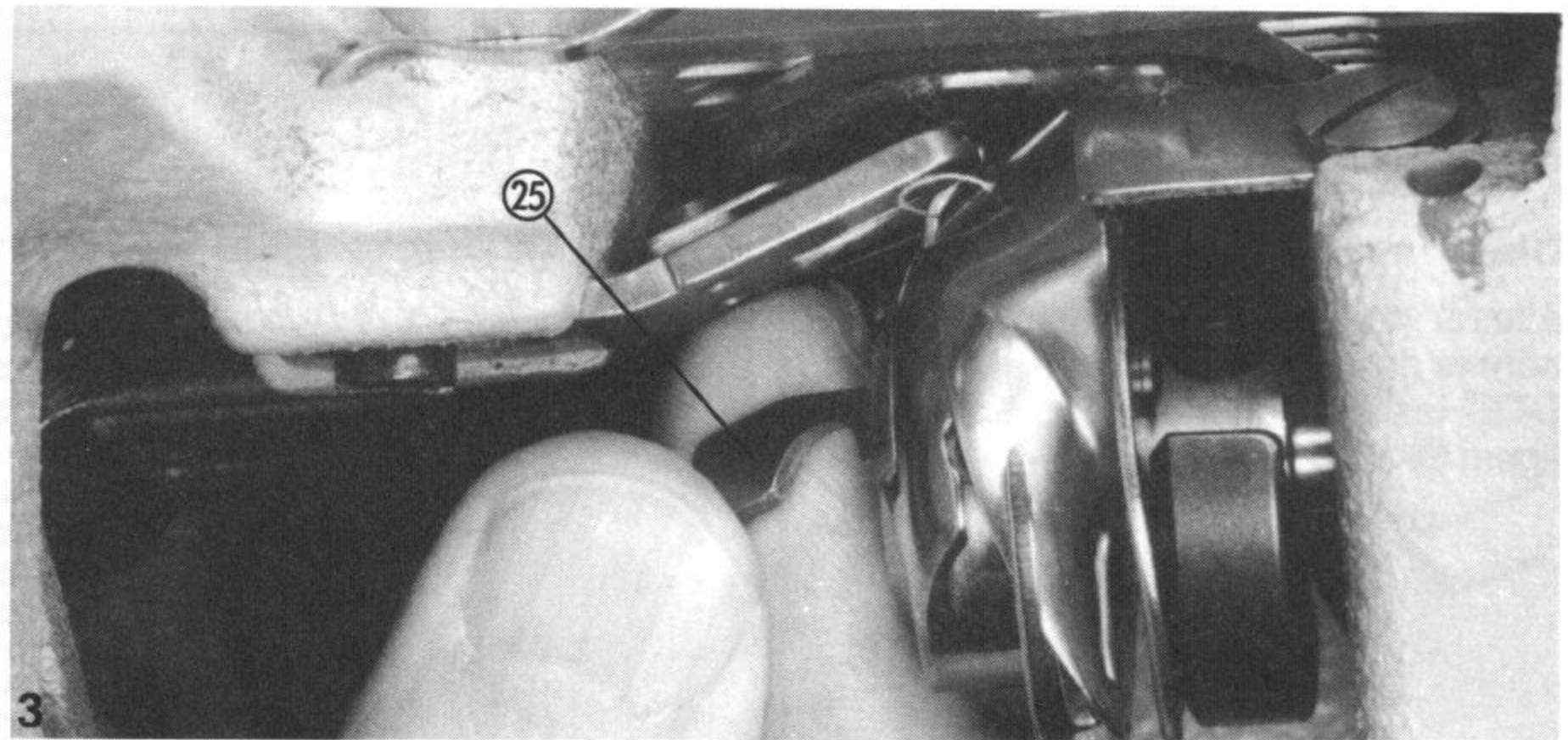

### Removing the bobbin case

Lift the latch ②⑤ (Fig.3) with the index finger of the left hand, grip with thumb and index finger and remove bobbin case.

When the latch is released, the bobbin is free and can be taken out of the bobbin case.

### Winding the lower thread

Threading sequence see Fig. 4 + 5.

Press engaging lever ②③. Bobbin is wound automatically during sewing.

For machines with releaseable hand wheel:

Hold hand wheel and turn release screw ②⑥ anti-clockwise to stop. Wind bobbin. To sew tighten release screw ②⑥.

Inserting the bobbin, threading, see Fig. 6.

Hold bobbin case with the open latch ②⑤, as when removing, with thumb and index finger of left hand so that the notch of the case is upwards. Insert in hook.

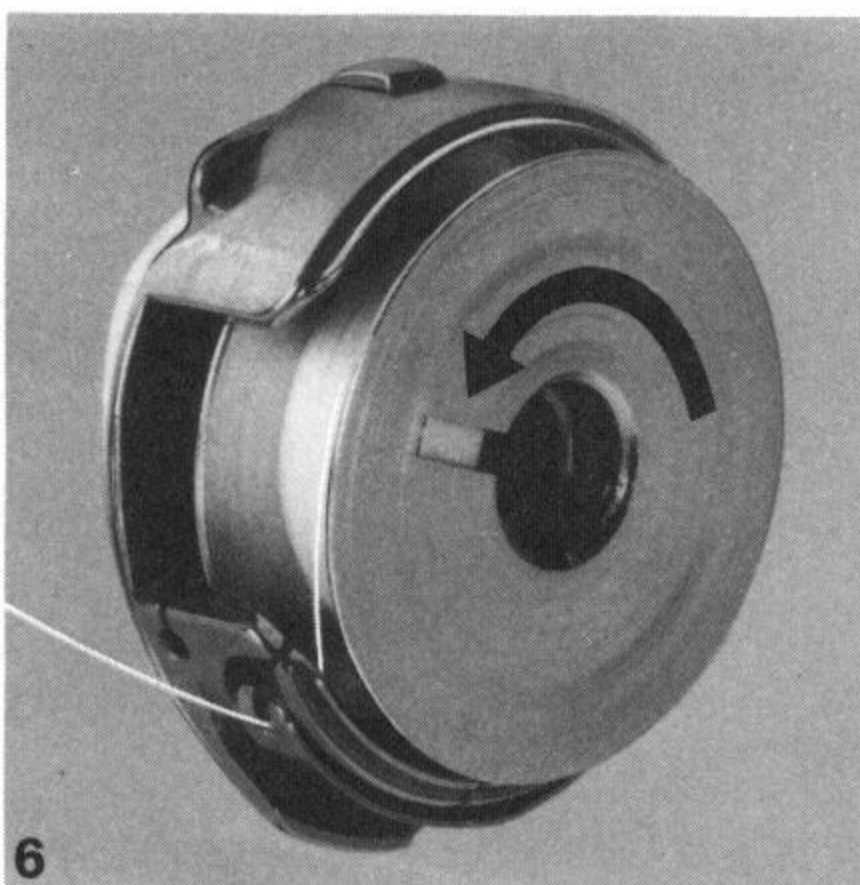
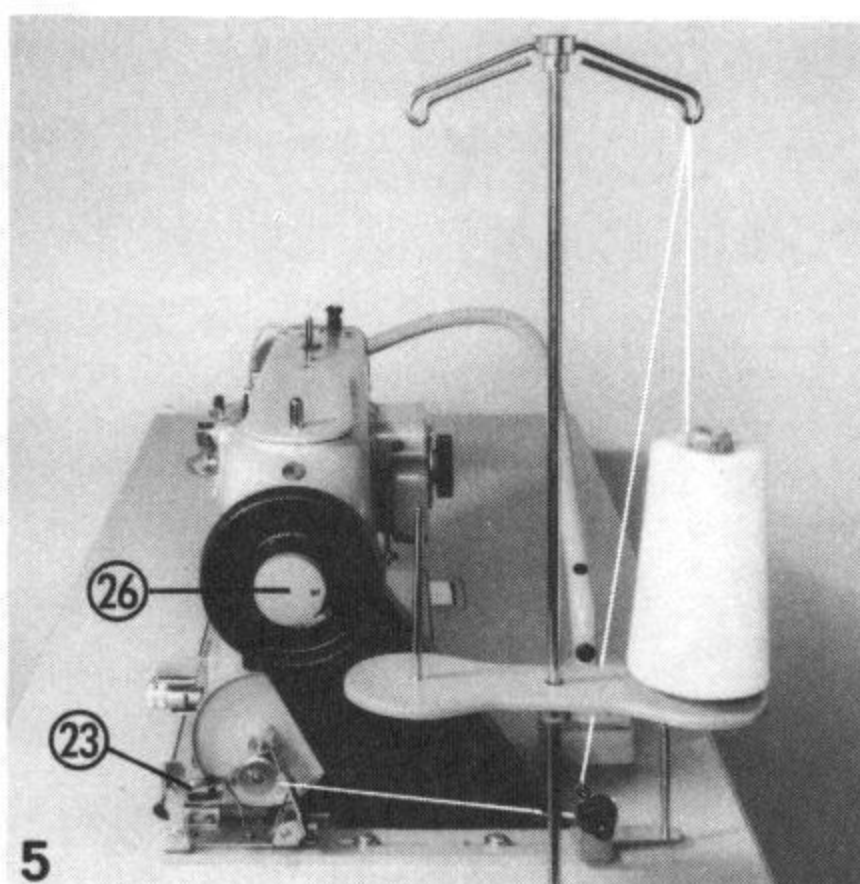

# GLOBAL

## Threading upper thread

## Bringing up lower thread

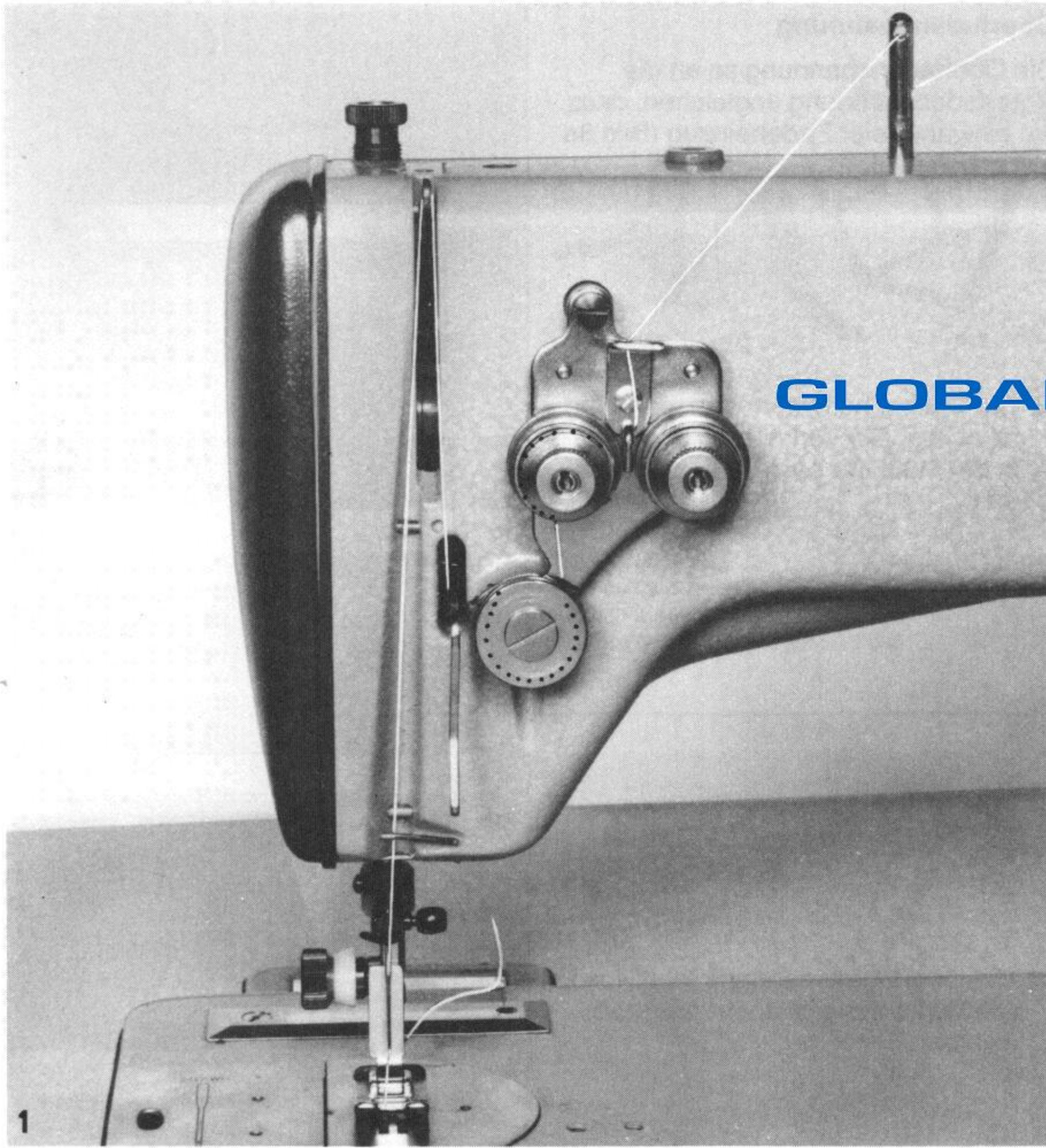

Sequence of threading (Fig. 1).

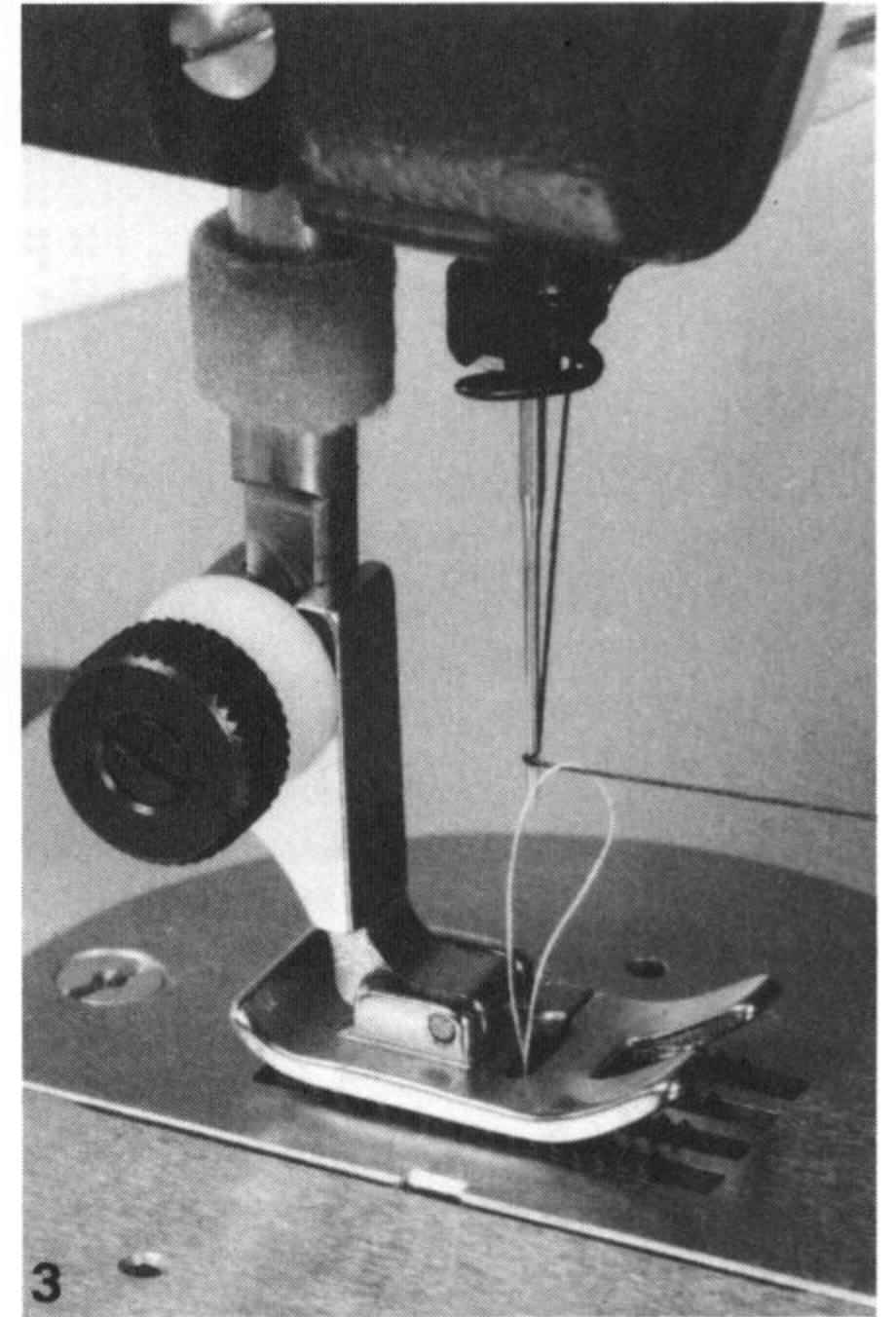

Lower presser foot. Hold end of upper thread with the left hand and turn hand wheel once towards you until the thread take-up lever is approximately in the highest position. Pull lightly on end of upper thread until the lower thread comes up through the needle plate (Fig. 3). Hold both ends lightly or lay them under the presser foot when starting sewing.

## Thread tension

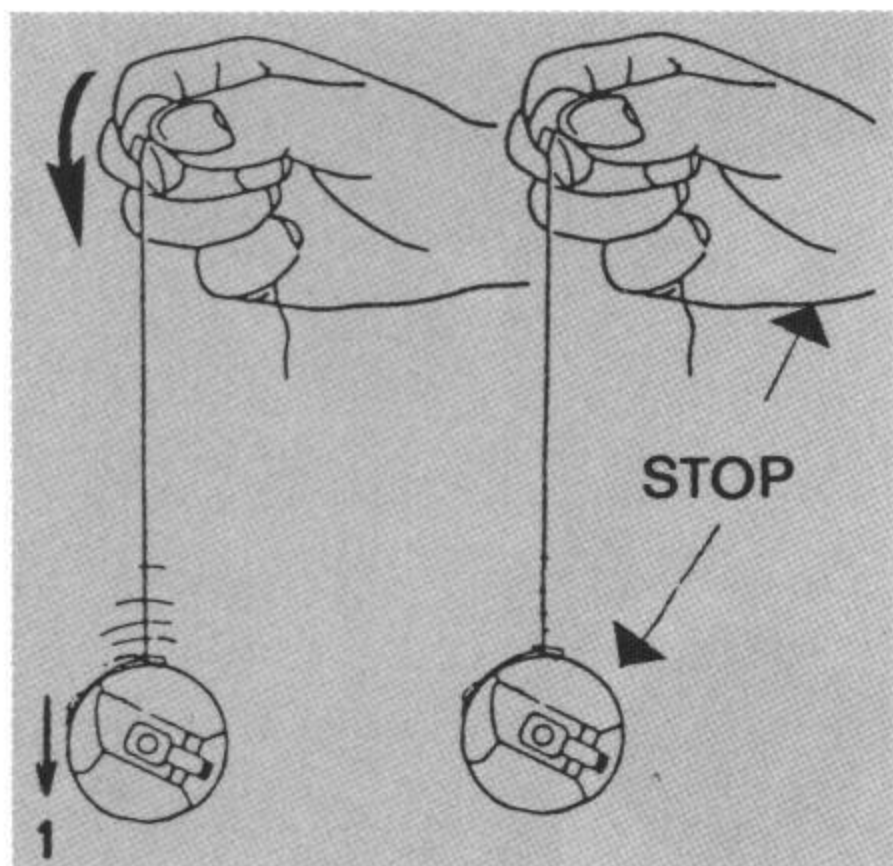

Normal lower thread tension  
Jerky hand movement = bobbin case slowly moves down  
Hand still = bobbin case still (Fig. 1).

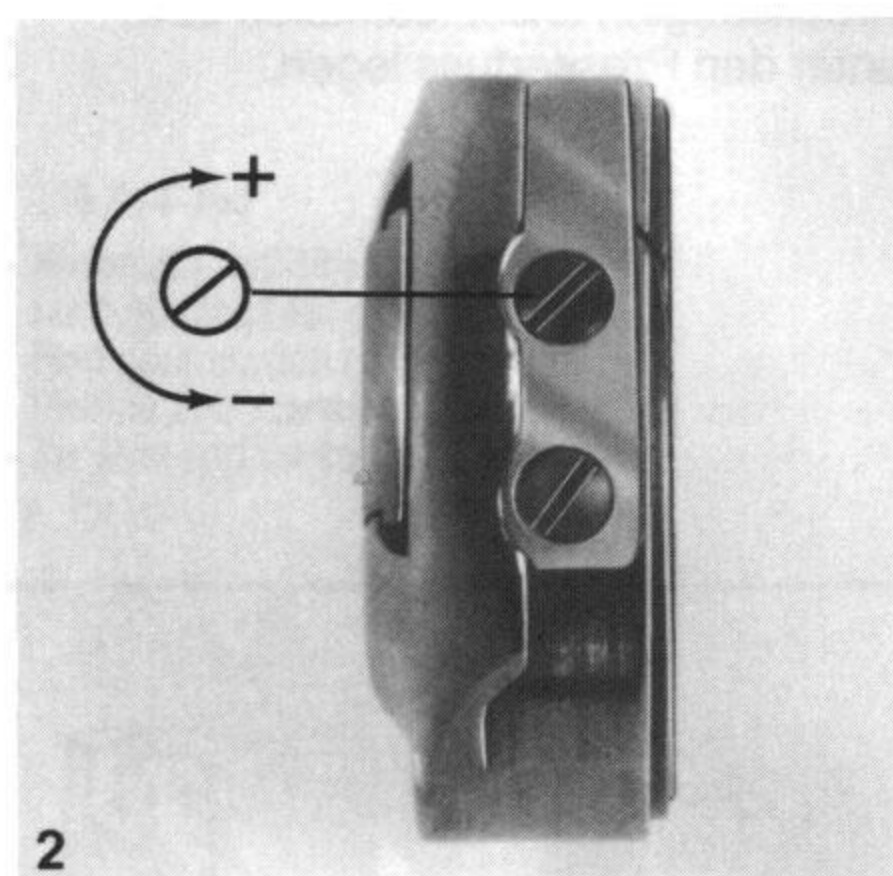

Adjusting the lower thread tension (Fig. 2)

tighter +  
tension screw  
looser -

### Upper thread tension

Adjust the upper thread tension to that of the lower thread so that the thread is pulled in evenly (Fig. 3a-c).

a) The upper and lower thread tension is correct. The knot is formed in the centre of the two layers of fabric.

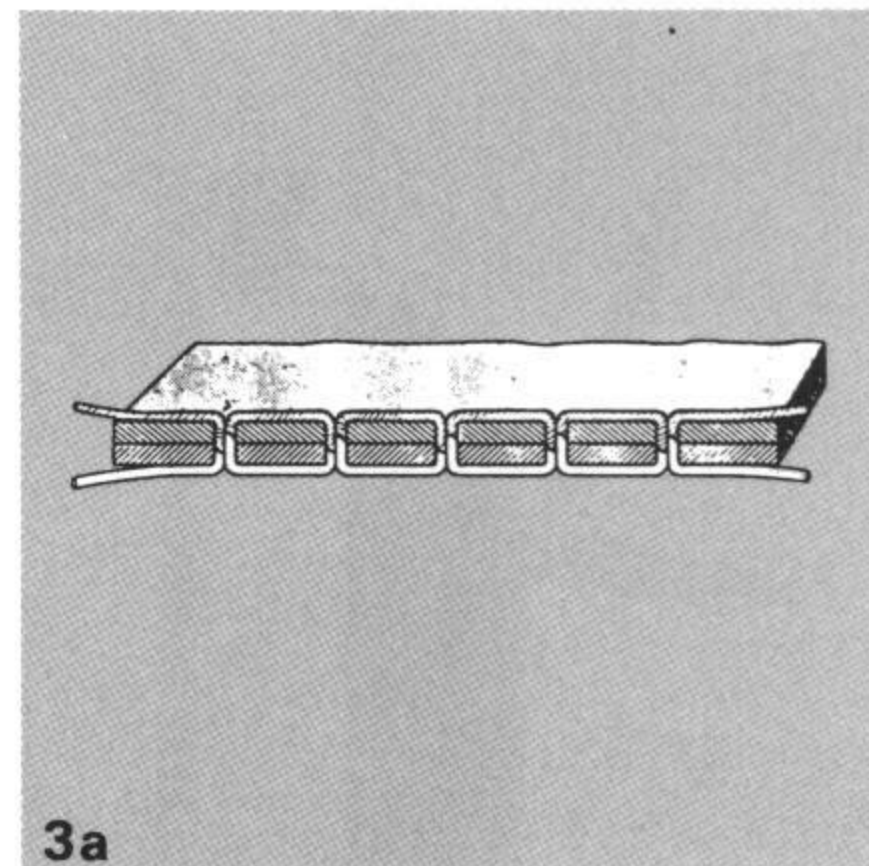

b) The upper thread tension is too loose. The knots can be seen on the underneath of the fabric.

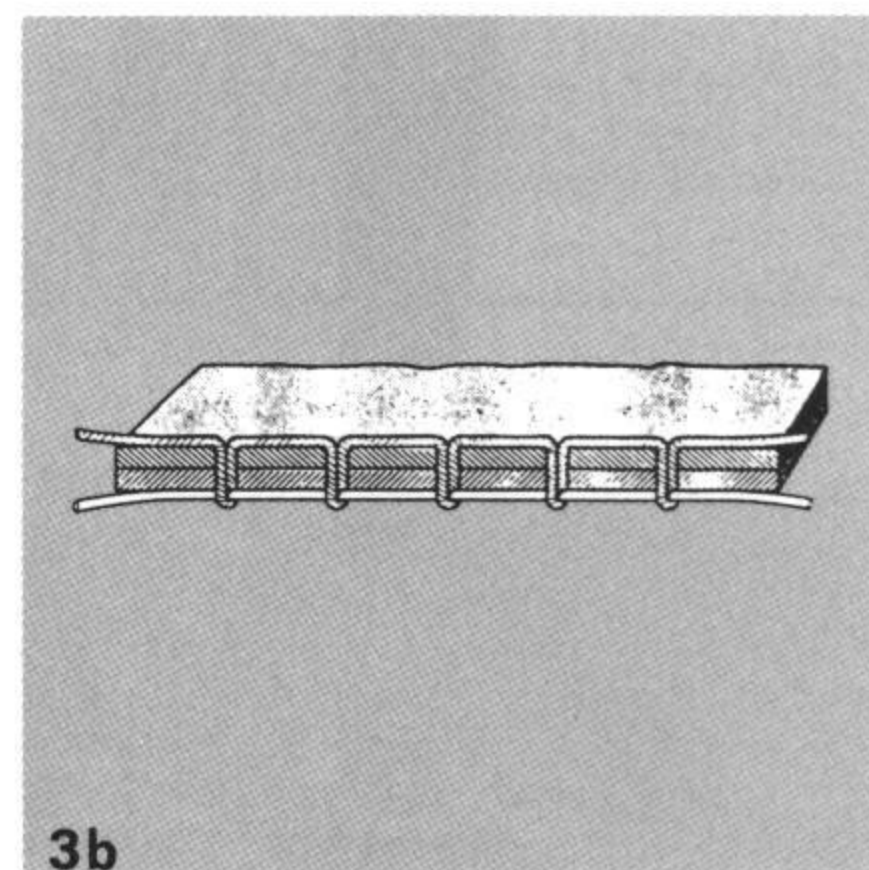

c) The upper thread tension is too tight. The knots can be seen on the top of the fabric.

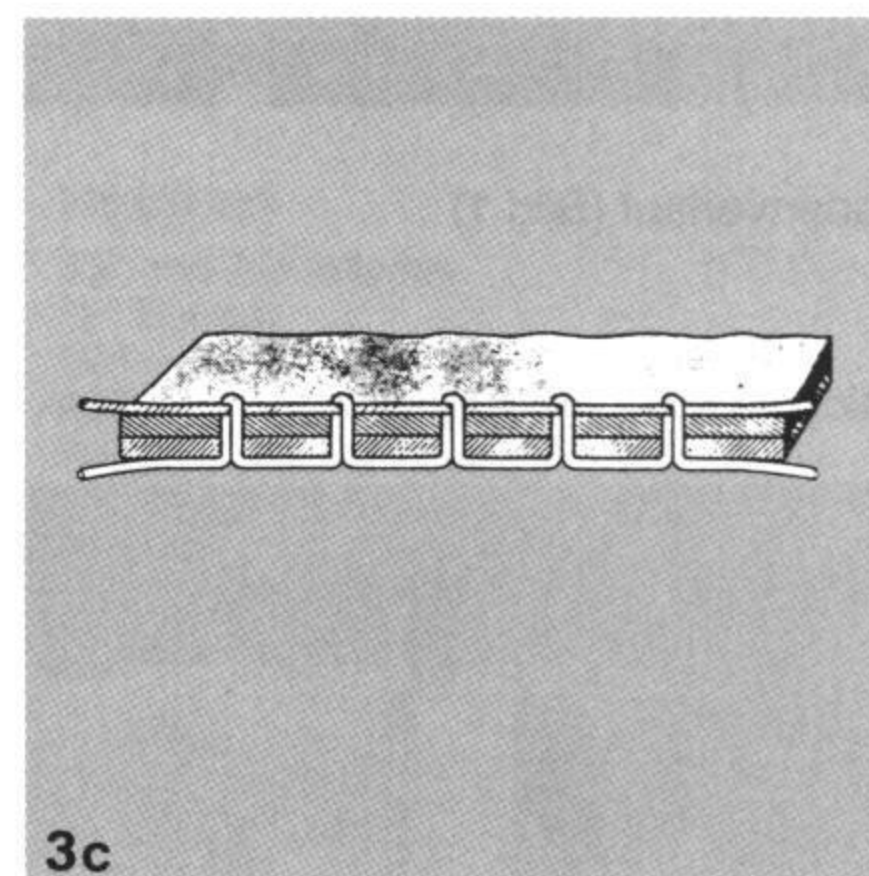

## Setting the stitch width

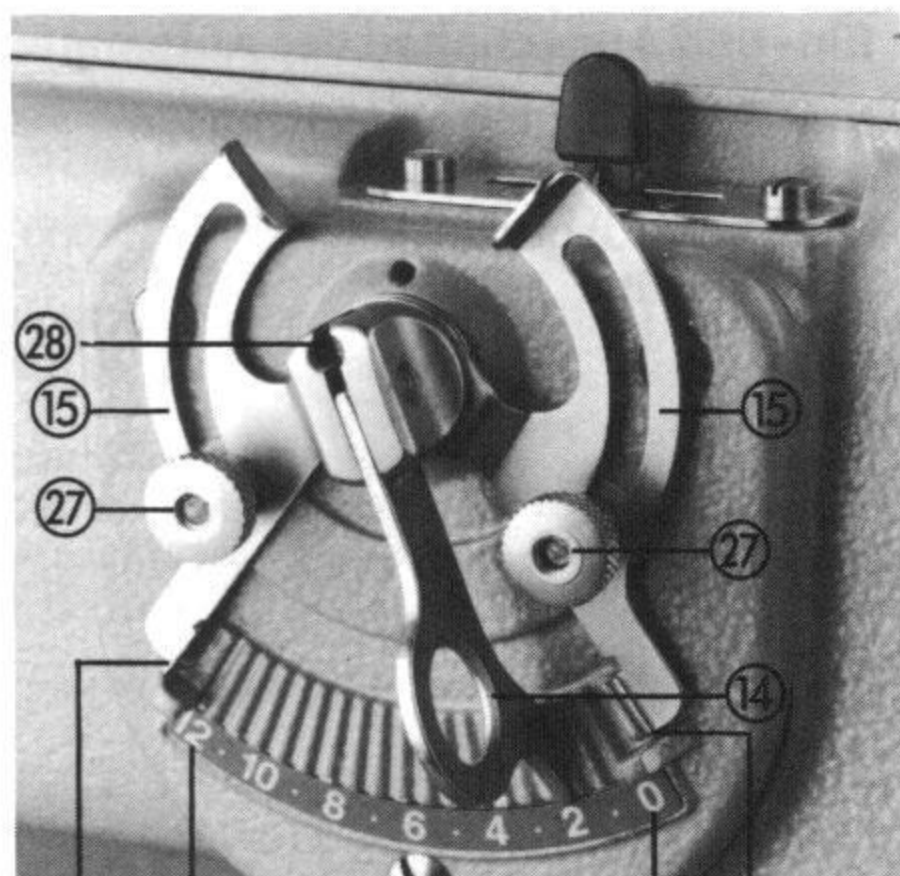

1

Lever ⑭ for full adjustment of stitch width.

Stops ⑮ with knurled nuts ⑳ limit the stitch width. The stops can be by-passed by lifting the lever ⑭ (Fig. 1).

The lever ⑭ may only be moved during sewing. When the machine is at a standstill, the needle must be out of the fabric.

## Setting the needle position

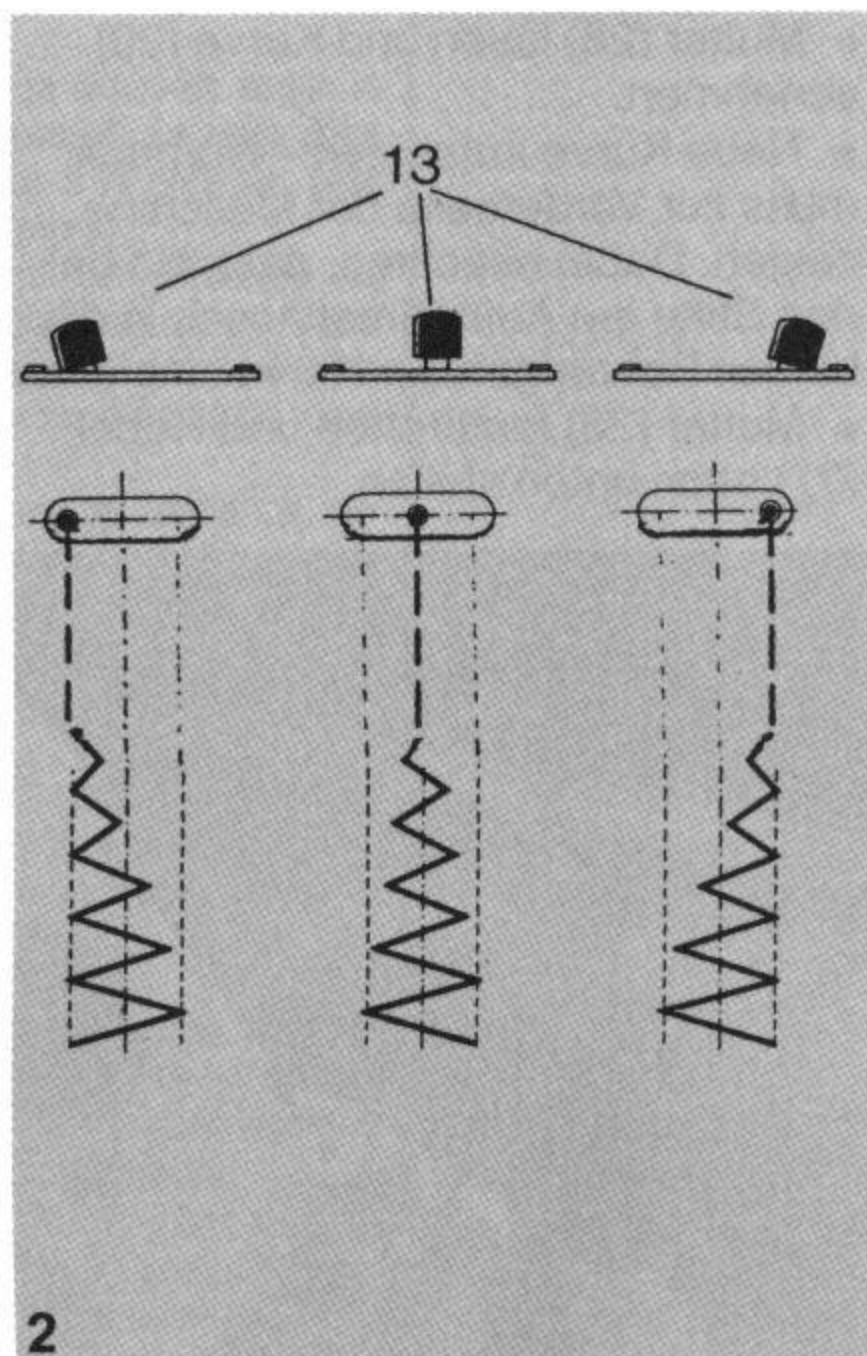

2

The lever ⑬ for the stitch position can be set from left to right in seven positions. It too may be moved during sewing but again when the machine is at a standstill, the needle must be out of the fabric (Fig. 2).

The stitch is limited to 8 mm on one side when the needle position is left or right.

## Setting the stitch length

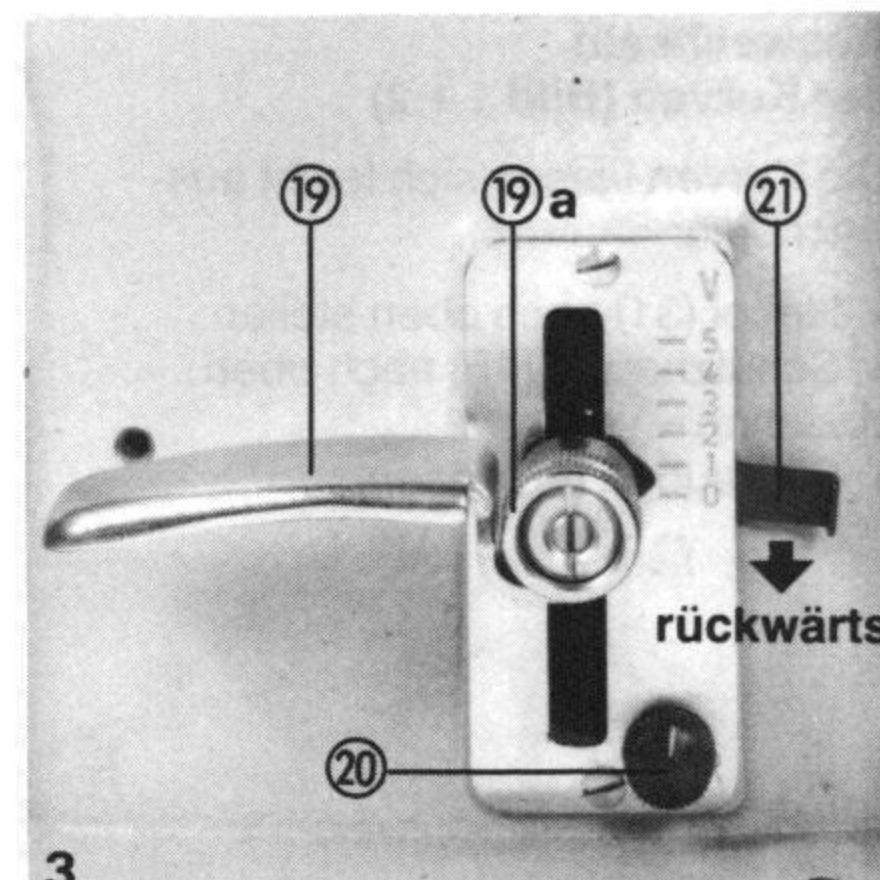

3

The stitch length is set forwards and reverse by turning the knob (19a) (Fig. 3).

Fine setting for satin stitch:

Press lever ⑲ downwards. Slide stop ㉑ to left.

Fine setting with knob ㉒.

If the stop ㉑ is pushed right again, the machine sews with the stitch length previously set.



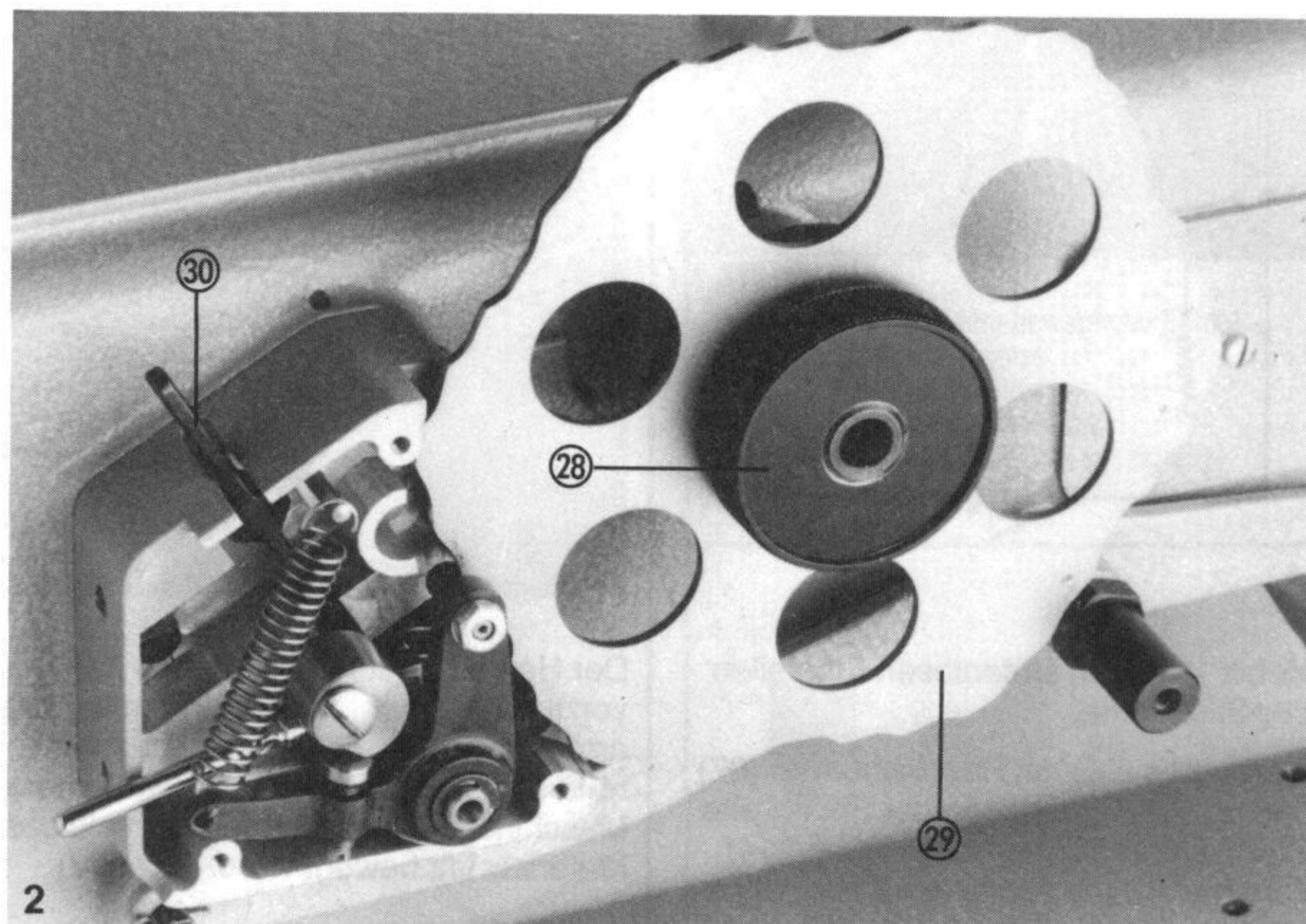
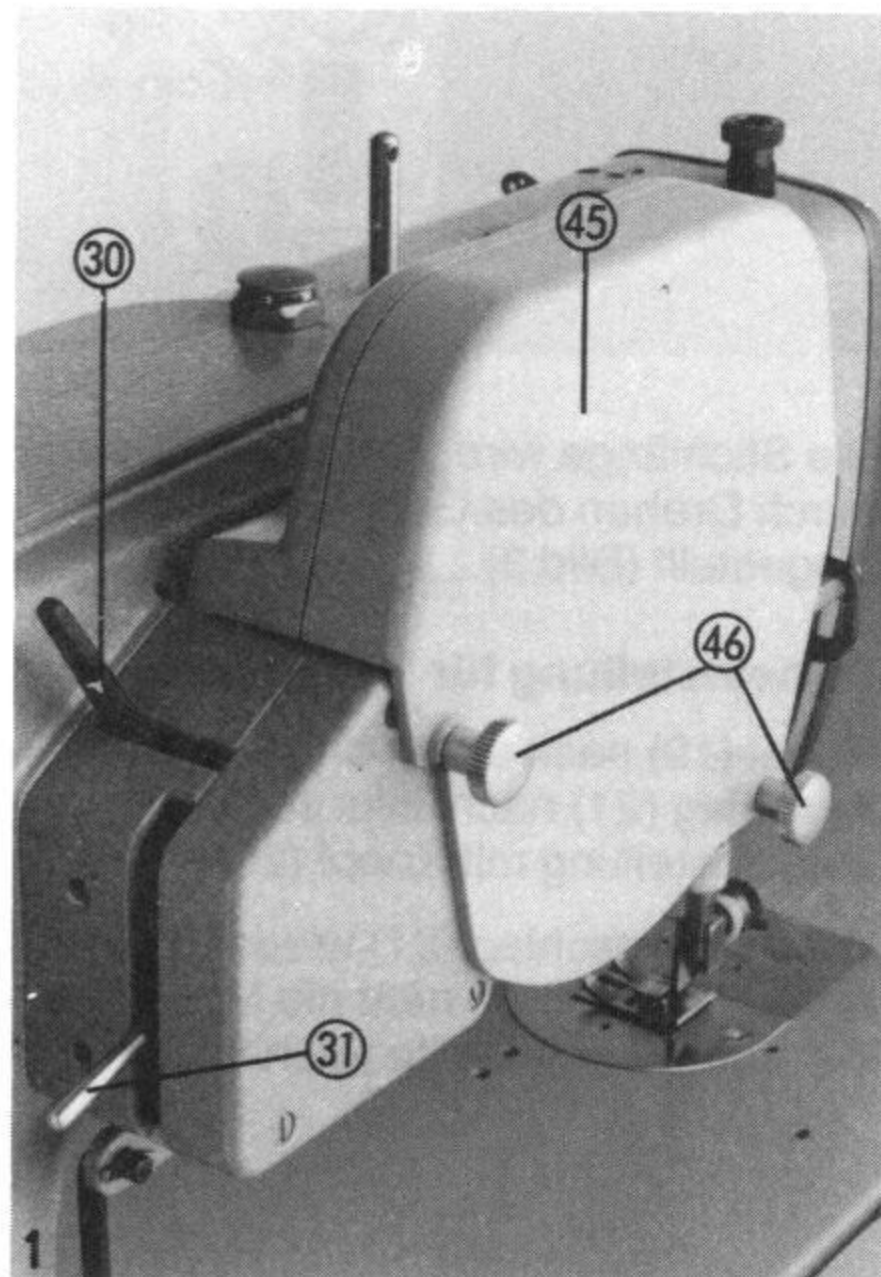

## Cam device for utility and decorative stitches

### Changing the cams (Figs. 1 + 2)

The cams are easy to change:

- Place lever (31) in up position.
- Pull off protective cover (45) upwards.
- Loosen nut (28) and remove cam (29).
- Loosen screws (46).
- Position new cam – the number must face the operator. Ensure that both pins on the flange engage into the cam holes.
- Tighten nut (28) and push lever (31) down.

### Switching automatic cam device on and off

- Lever (30) out: switched off
- Lever (30) against the arm of the machine: switched on.

## Puller attachment

Lifting lever for roller and presser foot ③②  
(Fig. 1)

**Position A:**

Roller and presser foot are lowered, are lying on the fabric and feeding it. Both are lifted with the knee lever.

**Position B:**

The roller is raised. Only the presser foot is lifted with the knee lever.

Adjusting the stitch length:

First set the desired stitch length with screw ③③, then set the stitch length on the machine slightly smaller.

Check:

Adapt the stitch length on the machine so that the fabric is slightly stretched between roller and presser foot.

Roller pressure regulating screw ③⑤

(Fig. 2)

Roller pull:

If for special work you wish the roller to pull slightly to the left or right, this can be done as follows: Place lever ③② on A (roller lies on fabric). Turn screw ③⑥ slightly and turn roller a little.

Removing the roller:

Loosen screw ③③ and pull out to the back, place lever ③② on B, loosen screw ③⑦ with 2.5 mm Imbus wrench and remove roller support downwards. The machine can now be used without the puller.

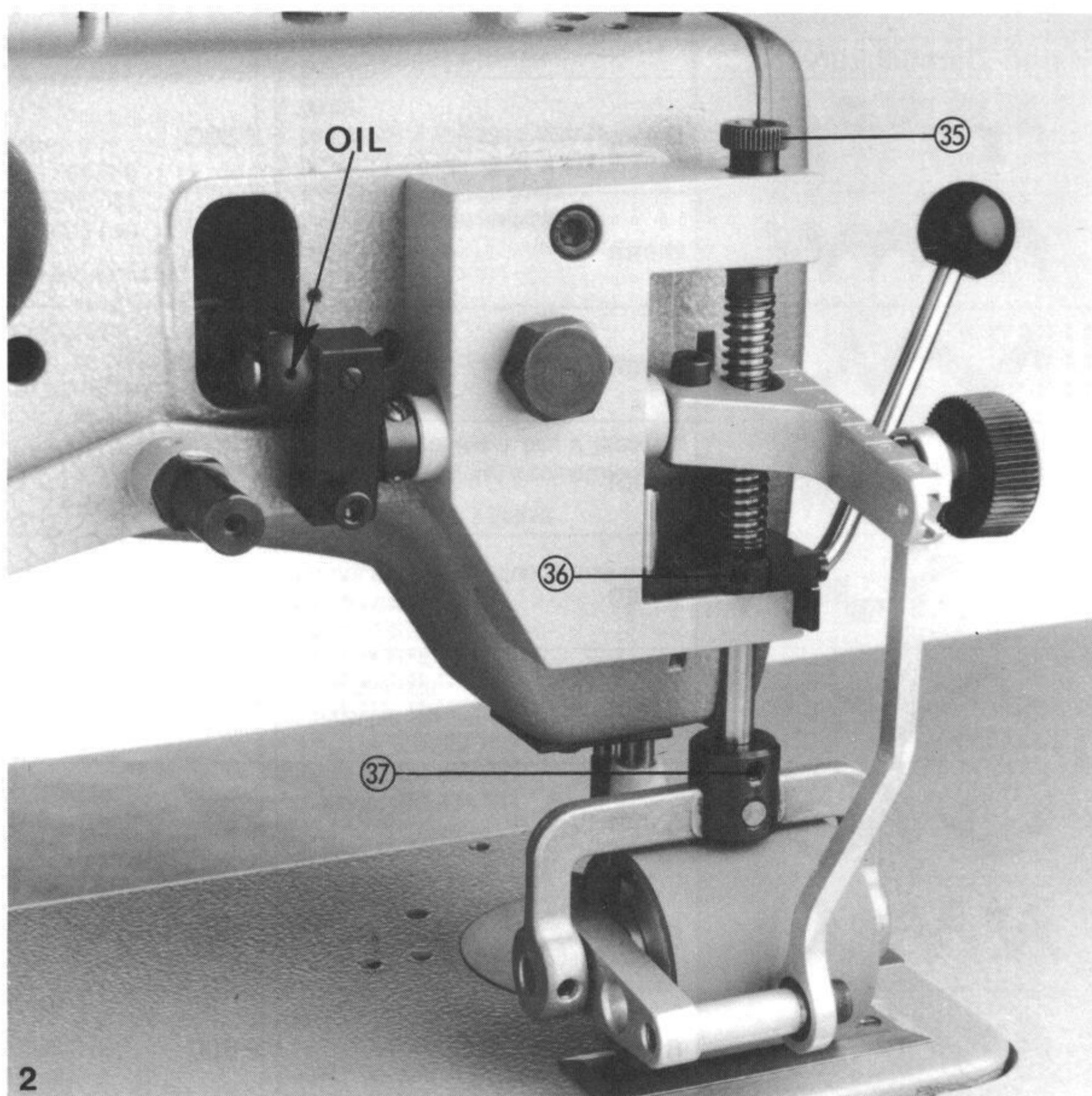
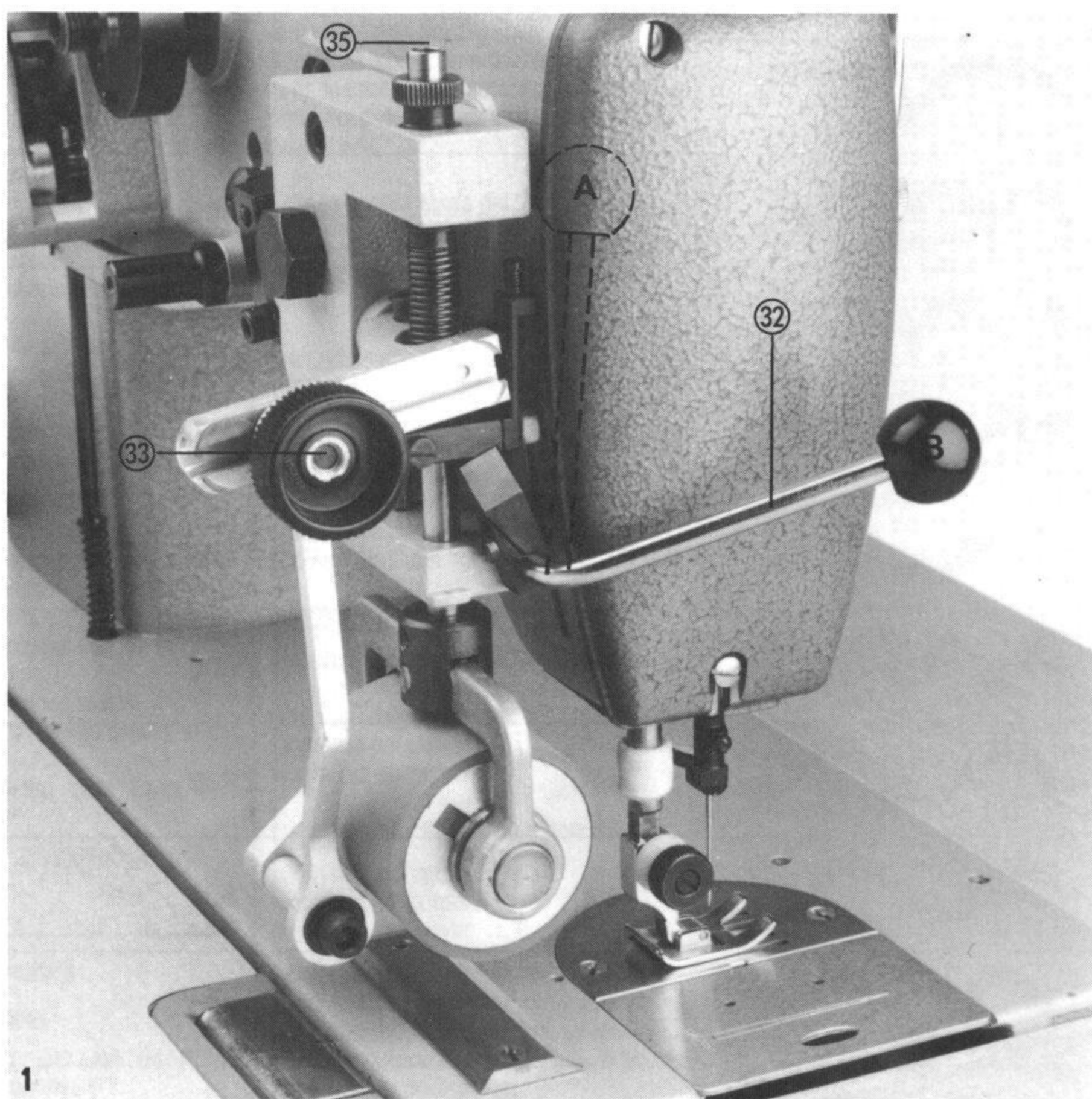

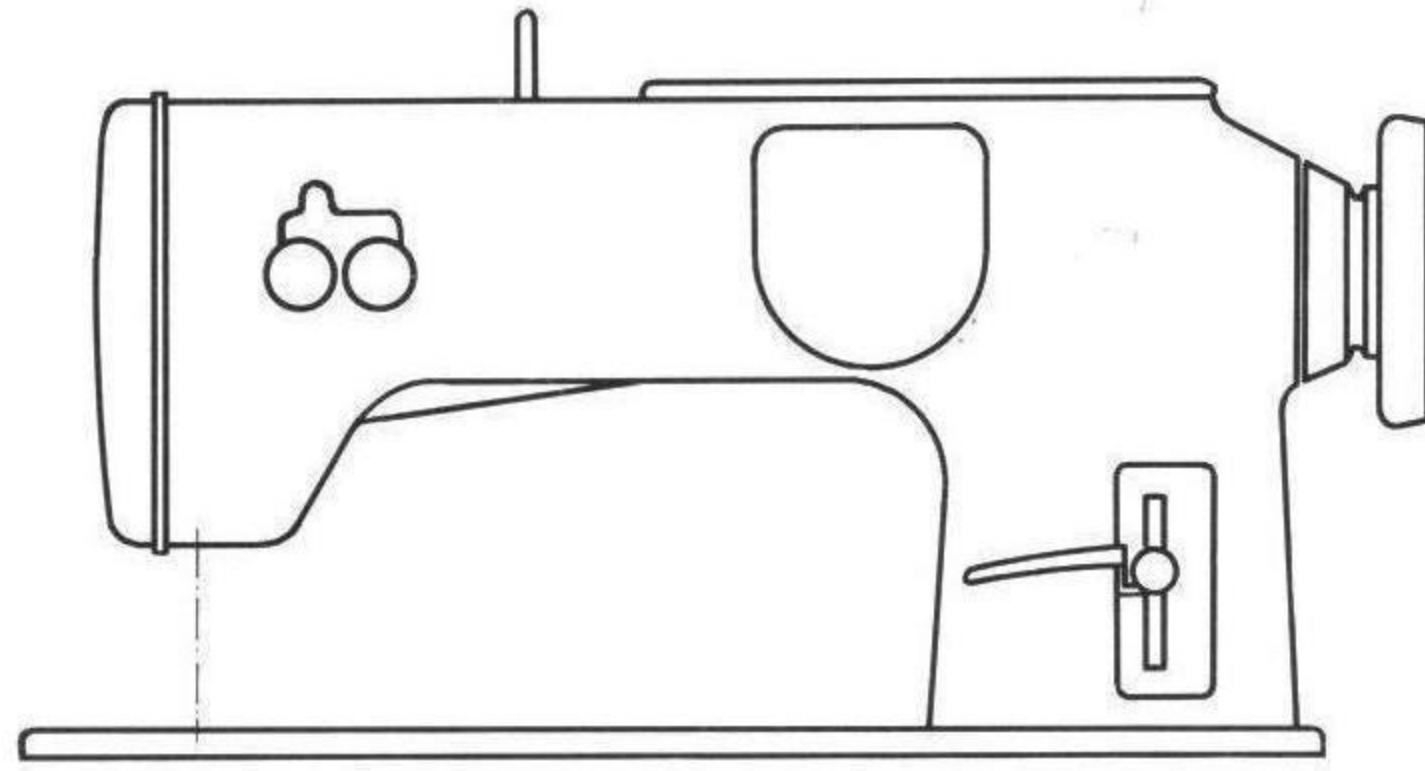

**GLOBAL ZZ 217**

**GLOBAL ZZ 217-3S**

**GLOBAL ZZ 217-P-3S**

[www.globalsew.com](http://www.globalsew.com)